

INSTRUCTION MANUAL

HVLP Compliant Spray gun Low Volume Low Pressure LPH-400-LVB/-LVC/-LVX

Important

This manual contains IMPORTANT WARNINGS and INSTRUCTIONS. Equipment in this manual is exclusively for painting purposes. Do not use for other purposes.
The operator shall be fully conversant with the requirements stated in this instruction manual including important warnings, cautions and operation and correct handling.
Read and understand the instruction manual, before use and retain for reference.

CE Ex II 2G X

This Anest-iwata spray gun kit complies to ATEX regulations 94/9/EC,
Protection level :
II 2G X , Suitable for use in Zones 1 and 2.
X marking :
Any static electricity discharge from the spray gun is to be diverted to the grounded the conductive air hose as stipulated.

Be sure to observe warnings and cautions in this instruction manual.
If not, it can cause paint ejection and serious bodily injury by drawing organic solvent.
Be sure to observe following marked items which are especially important.

WARNING	Indicates a potentially hazardous situation which, if not avoided, may result in serious injury or loss of life.
CAUTION	Indicates a potentially hazardous situation which, if not avoided, may result in minor or moderate injury or property damage.
Important	Indicates notes which we ask you to observe. The safety precautions in this instruction manual are the minimum necessary conditions. Follow national and local regulations regarding fire prevention, electricity and safety as well as your own company regulations.

Important specifications

Max. Pressure	0.68MPa / 6.8 bar / 98 PSI
Noise level	69.4 dB (A)
Spray condition	Recommended
Measuring point	1m backwards from gun, 1.6 m height
Max. Temperature	
Atmosphere	5°C~ 40°C

Main specifications

Model	Type of feed	Nozzle orifice φ mm (in)	Air cap set Mark	Recommended condition					Air & fluid connection	Mass g (lbs)
				※1 Atomizing air pressure MPa (bar /PSI)	Air pressure inside air cap MPa (bar /PSI)	Fluid output ml/min	Air consumption l/min (cfm)	Pattern width mm (in)		
LPH-400-124LVC	Gravity	1.2 (0.047)	LV4	0.11(1.1/16)	0.07 (0.7/10)	90	270 (9.5)	260 (10.2)	G1/4(Air) (NPS1/4) M16×1.5 (Fluid)	380 (0.84)
LPH-400-134LVC		1.3 (0.051)				110		280 (11.0)		
LPH-400-144LVC		1.4 (0.055)				130		290 (11.4)		
LPH-400-154LVC		1.5 (0.059)				140		295 (11.6)		
LPH-400-164LVC		1.6 (0.063)				150		300 (11.8)		
LPH-400-184LVC		1.8 (0.071)				190		320 (12.6)		
LPH-400-134LVB		1.3 (0.051)	LVB	0.1 (1.0/14)	0.07 (0.7/10)	95	235 (8.3)	320 (12.6)		
LPH-400-144LVB		1.4 (0.055)				110		325 (12.8)		
LPH-400-154LVB		1.5 (0.059)				125		335 (13.2)		
LPH-400-134LVX		1.3 (0.051)	LVX	0.11(1.1/16)	0.07 (0.7/10)	120	275(9.8)	300(11.8)		
LPH-400-144LVX		1.4 (0.055)				130		310(12.2)		
LPH-400-154LVX		1.5 (0.059)				145		330(13.0)		

※1. Atomizing air pressure means air pressure at gun inlet when trigger is pulled and air flows .

■ Safety precautions

WARNING

Fire and explosion

1. Spark and open flames are strictly prohibited.

Paints can be highly flammable and can cause fire.
Avoid any ignition sources such as smoking, open flames, electrical goods, etc.



2. Never use the following HALOGENATED HYDROCARBON SOLVENTS

which can cause cracks or dissolution on gun body (aluminum) by chemical reaction.

- unsuitable solvents : methyl chloride, dichloromethane, 1,2-dichloroethane, carbon tetrachloride, trichloroethylene, 1,1,1-trichloroethane

(Be sure that all fluids and solvents are compatible with gun parts.
We are ready to supply a material list used in the product)



3. Securely ground spray gun by using air hose with built-in ground wire.

Ground wire : Less than 1 MΩ . Check the earth stability periodically.
If not, insufficient grounding can cause fire and explosion due to static electric sparking.

Improper use of equipment

1. Never point gun toward people or animal.

If done, it can cause inflammation of eyes and skin or bodily injury.

2. Never exceed maximum operating pressure and maximum operating Temperature.

3. Be sure to release air and fluid pressures before cleaning, disassembling or servicing.

If not, remaining pressure can cause bodily injury due to improper operation or scattering cleaning liquid.
In order to release pressure, first stop supply of compressed air, fluid and thinner to spray gun.

Then remove trigger toward you.

4. Tip of fluid needle set has a sharp point .

Do not touch the tip of fluid needle during maintenance for the protection of the human body.



Protection of human body

1 . Use in a well-ventilated site by using spray booth.

If not, poor ventilation can cause organic solvent poisoning and catch fire.

2 . Always wear protective gear (safety glasses, mask, gloves) .

If not, cleaning liquid, etc., can cause inflammation of eyes and skin.
If you feel something wrong with eyes or skin, immediately see a doctor.

3 . Wear earplugs if necessary.

Noise level can exceed 85 dB (A), depending on operating conditions and painting site

4 . If operators pull the trigger many times during operation, it may cause carpal tunnel syndrome.

Be sure to take a rest if you feel tired.



Other precautions

1 . Never alter this spray gun.

If done, it can cause insufficient performance and failure.

2 . Enter working areas of other equipment (robots, reciprocators, etc.) after machines are turned off.

If not, contact with them can cause injury.

3 . Never spray foods or chemicals through this gun.

If done, it can cause accident by corrosion of fluid passages or adversely affect health by mixed foreign matter.

4 . If something goes wrong, immediately stop operation and find the cause. Do not use again until you have solved the problem.

■ How to connect

CAUTION

-Use clean air filtered through air dryer and air filter. . . . If not, dirty air can cause painting failure.

-If you use this gun for the first time after purchasing, clean fluid passages spraying thinner and remove rust preventive oil.

If not, remaining preventive oil can cause painting failure such as fish eyes.

-Firmly fix hose or container to spray gun. . . . If not, disconnection of hose and drop of container can cause bodily injury.

Job1. Connect an air hose to air nipple tightly.

Job2. Connect an applicable cup, PCG-6P-M (Option), to fluid nipple tightly.

Job3. Flush the gun fluid passage with a compatible solvent.

Job4. Pour paint into container, test spray and adjust fluid output as well as pattern width.

■ How to operate

Recommended paint viscosity differs according to paint property and painting conditions 12 to 23 sec./Ford cup#4 is recommendable.

Keep fluid output as small as possible to the extent that the job will not be hindered. It will lead to better finishing with fine atomization.

Set the spray distance from the gun to the work piece as near as possible within the range of 100-200mm(3.9~7.9 in) As this gun is operated at low air pressure, high transfer efficiency will not be obtained if the spray distance is too far.

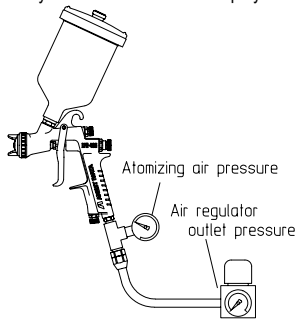

The gun should be held so that it is perpendicular to the surface of the work piece at all times. Then, the gun should move in a straight and horizontal line. Arcing the gun causes uneven painting.

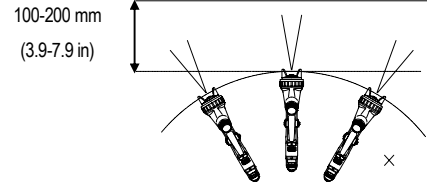

Pulling the trigger of the gun with the pattern adj. Set and fully opened adjust the air regulator in the spray booth to obtain 1.0~1.3 bar (14~18 PSI) at the gun inlet as issued on specifications table ahead. In this way the gun will atomize within 0.7 bar (10 PSI) inside air cap.

NOTE

Using air hose 12m (39.4ft) long, the inner diameter must be a minimum 8 mm (0.315 in) so the gun can have the correct air volume to atomize at 0.7 bar (10 PSI) inside air cap.

■ Maintenance and inspection

⚠ WARNING

- First release air and pressure fully according to item No. 3 of "Improper use of equipment" of WARNING on page 2.
- Tip of fluid needle set has a sharp point. Do not touch the tip of needle valve at the maintenance for protection of the human body.
- Be careful not to damage the tip of fluid nozzle or must not put your hand on it.
- Only an experienced person who is fully conversant with the equipment can do maintenance and inspection.

⚠ CAUTION

- Never use commercial or other parts instead of ANEST IWATA original spare parts.
- Never immerse the whole gun into liquid such as thinner.
- Never soak air cap set in solvent for extended period even if cleaning. It may cause defective pattern.
- Never damage holes of air cap a fluid nozzle and fluid needle.

Step-by-step procedure	Important
1. Pour remaining paint to another container. Clean fluid passages and air cap set. Spray a small amount of thinner to clean fluid passages.	1. Incomplete cleaning can fail pattern shape and uniform particles. Especially clean fully and promptly two-component paint after use.
2. Clean each section with brush soaked with thinner and wipe out with waste cloth.	2. Soaking whole spray gun in solvent may cause spray gun malfunction. Also soaking air cap set itself for extended period. When cleaning, never scratch each hole of air cap set and fluid nozzle, and fluid needle set.
3. Before disassembly, fully clean fluid passages. (1)Disassemble fluid nozzle. Use ring spanner, box wrench or optional exclusive spanner (code 03538600) to remove fluid nozzle. (2)Disassemble fluid needle set. You do not need to remove fluid adj. guide set from gun body. Remove fluid adj. knob and fluid needle spring, and then pull out fluid needle spring, and then pull out fluid needle set from back of fluid adj. guide set.	3. During disassembly, do not scratch seat section. (1)Remove fluid nozzle after removing fluid needle set or while keeping fluid needle pulled, in order to protect seat section. (2)Be careful when handing tip of fluid needle set since it is sharp. Disassemble fluid adj. guide set as little as possible.
4. When you want to adjust fluid needle packing set, first tighten it by hand while fluid needle set remains inserted. Then tighten it further about 1/6 turn (60-degree) by spanner.	4. If you tighten fluid needle packing set too much, fluid needle set will not move smoothly, resulting in paint leakage from tip of fluid nozzle. Try to adjust it carefully while pulling trigger and confirming movement of fluid needle set. When you tighten it too much, first fully loosen it and then tighten it again carefully.
5. In order to assemble air valve, first assemble air valve & air valve spring & fluid adj. guide set together. Next, insert fluid needle set into fluid adj. guide set, then fit it to gun body set and screw fluid adj. guide set.	5. If you try to fit air valve spring and air valve to gun body set without fluid needle set, air valve will not be fitted correctly and lop packing inside fluid adj. guide set will be damaged.
6. Turn pattern adj. knob or air adj. knob counterclockwise to fully open. And then tighten pattern adj. set or air adj. set.	6. If pattern adj. Knob or air adj. Knob is not fully opened, tip of it can contact and damage fluid nozzle and cause seizure of thread.

Where to inspect	Parts replacement standard
1. Each hole passage of air cap and fluid nozzle	Replace if it is crushed or deformed.
2. Packing and O ring	Replace if it is deformed or worn out.
3. Leakage from seat section between fluid nozzle and fluid needle set	Replace them if leakage does not stop after fully cleaning fluid nozzle and fluid needle set. If you replace fluid nozzle or fluid needle set only, fully match them and confirm that there is no leakage.

■ Parts list

When ordering parts, specify gun's model, part name with ref. No. and marked No. of air cap set, fluid nozzle and fluid needle.

When replacing fluid nozzle or/and fluid needle for pressure feed application, please order nozzle needle set.

Fluid nozzle-needle set combination		
Fluid nozzle		Fluid needle set
Orifice φ mm(in)	Mark	Mark
φ 1.2 (0.047)	400LV/12	40012
φ 1.3 (0.051)	400LV/13	20015
φ 1.4 (0.055)	400LV/14	
φ 1.5 (0.059)	400LV/15	
φ 1.6 (0.063)	400LV/16	
φ 1.8 (0.070)	400LV/18	20020





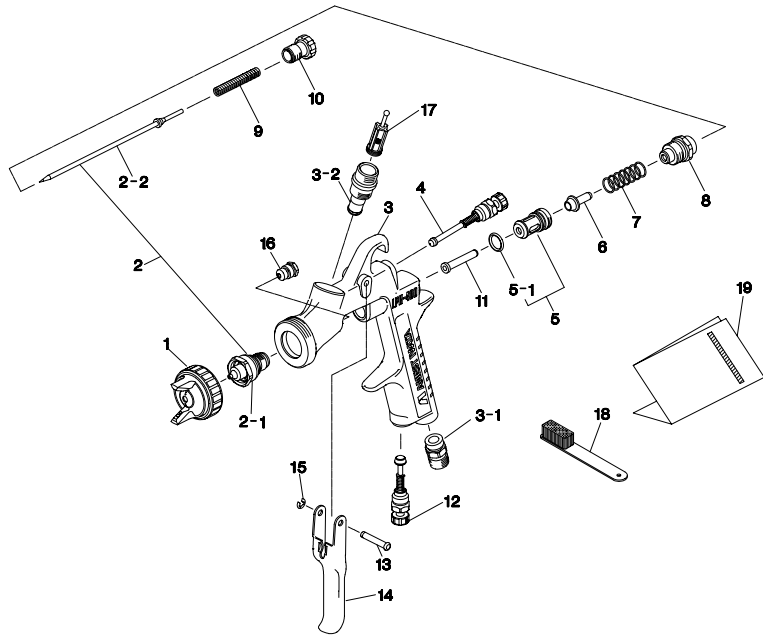

Parts List

No.	Description	Q'ty
1	Air cap set	1
2	Fluid nozzle-fluid needle set	1
2-1	Fluid nozzle	1
2-2	Fluid needle set	1
3	Body set	1
3-1	Air nipple	1
3-2	Fluid nipple	1
4	Pattern adj. set	1
5	Air valve seat set	1
5-1	O ring	1
6	Air valve	1
7	Air valve spring	1
8	Fluid adj. guide	1
9	Fluid needle spring	1
10	Fluid adj. knob	1
11	Air valve shaft	1
12	Air adj. set	1
13	Trigger stud	1
14	Trigger	1
15	E stopper	1
16	Needle packing set	1
17	Filter	1
18	Brush	1
19	Instruction manual	1

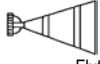
♦ Marked parts are wearable parts.

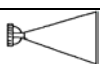

■ Troubleshooting

Spray Pattern	Problems	Remedies
 Fluttering	1. Air enters between fluid nozzle and tapered seat of gun body. 2. Air is drawn from fluid needle packing set. 3. Air enters at fluid container fitting nut or fluid hose joint.	1. Remove fluid nozzle to clean seat. If it is damaged, replace nozzle. 2. Tighten fluid needle packing. 3. Fully tighten joint section.
 Crescent	1. Paint buildup on air cap partially clogs horn holes. Air pressure from both horns differs.	1. Remove obstructions from horn holes with attached brush. But do not use metal objects to clean horn holes.
 Inclined	1. Paint buildup or damage on fluid nozzle circumference and air cap center. 2. Fluid nozzle is not properly fitted.	1. Remove obstructions. Replace if damaged. 2. Remove fluid nozzle and clean seat section.
 Split	1. Paint viscosity too low. 2. Fluid output too high.	1. Add paint to increase viscosity. 2. Tighten fluid adj. knob to reduce fluid output. Or turn pattern adj. valve set clockwise.
 Heavy Center	1. Paint viscosity is too high. 2. Fluid output is too low.	1. Add thinner to reduce viscosity. 2. Turn fluid adj. valve knob counter-clockwise to increase fluid output.
 Spit	1. Fluid nozzle and fluid needle set are not seated properly. 2. The first-stage travel of trigger (when only air discharges) decreases. 3. Paint buildup inside air cap set.	1. Clean or replace fluid nozzle and fluid needle set. 2. Replace fluid nozzle and fluid needle set. 3. Clean air cap set.

R1 : retighten R2 : adjust R3 : clean R4 : replace parts

Problem	Where it occurred	Parts to be checked	Cause	Remedy			
				R1	R2	R3	R4
Air leaks (from tip of air cup)	Air valve set	Air valve	* Dirt or damage on seat			○	○
		Air valve seat set	* Dirt or damage on seat ----- * Wear on air valve spring			○	○
		O ring	* Damage or deteriorated				○
		Fluid nozzle ~ fluid needle set	* Dirt, damage, wear on seat ----- * Loose fluid needle adj. knob ----- * Wear on needle spring			○	○
Paint leaks	Fluid nozzle	Fluid nozzle ~ gun body	* Insufficient tightening ----- * Dirt or damage on seat	○			○
		Fluid needle ~ packing set	* Needle does not return due to packing set too tight ----- * Needle does not return due to paint buildup on fluid needle		○	○	○
		Needle packing set ~ needle set	* Wear	○			○
	Fluid needle	Packing seat	* Insufficient tightening	○			
Paint does not flow	Tip of gun	Fluid adj. knob	* Insufficient opening		○		
		Tip hole of nozzle	* Clogged			○	
		Paint filter	* Clogged			○	○



ANEST IWATA Corporation

3176, Shinyosida cho, Kohoku-Ku,
Yokohama 223-8501, Japan

Manual No. T030-04
Code No. 03517651